

TROUBLESHOOTING

Having this problem?

The unit is not switching on

Please check the following points:

- Check battery polarity and replace discharged batteries.

Flash unit cannot be triggered when the mode "All" is selected

- Transmitter and receiver must have the same frequency channel settings.
- ELSP MODE: transmitter and receiver must have the same synchronisation mode settings: normal or speed sync mode.
- Activate the Elinchrom receiver in all EL-units with built-in receivers.
- Check that the transmitter version corresponds to your Canon, Nikon, Olympus or Sony camera.

Flash unit can not be triggered in TTL mode

- In TTL mode, only TTL compatible units can be triggered.
- Check if the group is enabled on the transmitter.

Some units are not triggering when the group mode is selected

- Check the group settings of the EL- flash unit.
- Reduce the distance to any unresponsive unit.
- Transmitter and receiver must have the same synchronisation mode settings: normal or speed sync mode.

The TEST button works, but the camera will not trigger flash units

- Check the hotshoe's fitting.
- Check the camera's settings (turn hotshoe communication on).
- Check that the transmitter version corresponds to your Canon, Nikon, Olympus or Sony camera.
- Check the list of compatible cameras.
- In TTL mode, the camera only triggers the unit.

Having this problem?

Some information is not displayed about Digital RX, Ranger RX or Style RX units

Please check the following points:

- Units equipped with a Transceiver RX are limited in remote features. These units can however be triggered and controlled (but with no visual feedback) by the Elinchrom Transmitter Pro.

Limited distance range

- Reposition the units.
- Increase the distance from walls and ceilings.
- ELSP Mode: In speed sync mode the distance range is reduced by approximately 50 %, so switch back to normal sync mode.
- Outdoors, the distance range could be reduced due to humidity, interferences, obstacles, etc.
- In TTL mode: the unit emits a sound signal when the maximum / minimum EV is reached. Try to reposition the unit or modify the EV setting.

Interference with other 2.4 GHz networks, unreliable triggering

- Try another frequency channel for both transmitter and receiver of the EL-unit.
- Reduce the distance between the flash unit and the transmitter.

Scanning EL-units: (Manual mode only) No EL-unit found, or some units are missing

- Switch on all enabled EL-units, go to setup and rescan.
- Frequency, group and ELSP mode settings must match with the transmitter.
- Ensure that all Elinchrom Transmitter Pro enabled units are operating on the latest Firmware.

DECLARATION OF CONFORMITY USA AND CANADA

EN This device complies with Part 15 of the FCC Rules and with Industry Canada licence-exempt RSS standard(s). Operation is subject to the following two conditions: (1) this device may not cause harmful interference, and (2) this device must accept any interference received, including interference that may cause undesired operation. This product complies with the Canadian ICES-003 Class B specifications.

FR Le présent appareil est conforme aux CNR d'Industrie Canada applicables aux appareils radio exempts de licence. L'exploitation est autorisée aux deux conditions suivantes: (1) ce dispositif ne doit pas produire de brouillage préjudiciable, et (2) ce dispositif doit accepter tout brouillage radioélectrique subi, même si le brouillage est susceptible d'en compromettre le fonctionnement. Cet appareil numérique de la classe B est conforme à la norme NMB-003 du Canada.

Radiation Exposure Statement

EN This equipment complies with portable RF exposure limit in Canada and the USA set forth an uncontrolled environment and is safe for intended operation as described in this manual. Further RF exposure reduction can be achieved if the product can be kept as far as possible from the user body.

FR Le produit est conforme aux limites d'exposition pour les appareils portables RF pour les Etats- Unis et le Canada établies pour un environnement non contrôlé. Le produit est sûr pour un fonctionnement tel que décrit dans ce manuel. La réduction aux expositions RF peut être augmentée si l'appareil peut être utilisé aussi loin que possible du corps de l'utilisateur.

FCC Class B Compliance note

This equipment has been tested and found to comply with the limits for a Class B digital device, pursuant to Part 15 of the FCC Rules. These limits are designed to provide reasonable protection against harmful interference in a residential installation. This equipment generates, uses and can radiate radio frequency energy and, if not installed and used in accordance with the instructions, may cause harmful interference to radio communications. However, there is no guarantee that interference will not occur in a particular installation. If this equipment does cause harmful interference to radio or television reception, which can be determined by turning the equipment off and on, the user is encouraged to try to correct the interference by one or more of the following measures:

- Reorient or relocate the receiving antenna.
- Increase the separation between the equipment and receiver.
- Connect the equipment into an outlet on a circuit different from that to which the receiver is connected.
- Consult the dealer or an experienced radio/television technician for help.

Any changes or modifications not expressly approved by the party responsible for compliance could void the user's authority to operate this equipment.

This device is limited to operation on permissible Part 15 frequencies, and is does not have the ability to be configured by end users or professional installers to operate outside the authorized bands.

Product name:	Elinchrom Transmitter Pro	Phone:	+41 21 637 26 77
Trade name:	ELINCHROM	Fax:	+41 21 637 26 81
Model number(s):	19366 Canon®/ 19367 Nikon® / 19337 Fujifilm® 19371 Sony®/ 19372 Olympus®/ 19336 Pentax®	Email:	elinchrom@elinchrom.ch
Name of responsible party:	Elinchrom LTD Av. de Longemalle 11 1020 Renens / Switzerland	*Canon®, Nikon®, Olympus®, Fujifilm®, Pentax® and Sony® are protected trademarks which do not belong to Elinchrom LTD	

DOWNLOAD THE ELINCHROM TRANSMITTER PRO USER GUIDE

Obtain the complete user guide using this link:

<https://www.bc.gs/eltp>



DOWNLOAD CONFORMITY

Find your declaration for EC conformity here:

<http://bc.gs/ec>



FIRMWARE UPDATE BY USB PORT

Please download our latest firmware and follow the instructions:

<http://bc.gs/fw>



Please check all security documents before use !

Elinchrom LTD - Elinchrom Transmitter Pro - No guarantee for misprints
Av. de Longemalle 11, P. O. Box-458, CH-1020 Renens, Switzerland,
E-mail: elinchrom@elinchrom.ch - www.elinchrom.com



is a registered trademark of ELINCHROM LTD, RENENS, SWITZERLAND

Quick Start Guide

Elinchrom Transmitter PRO
Firmware V.3.0



INSTALLING THE BATTERIES

Press the battery compartment cover and slide it across to open the battery cover (See Picture 1).
 Insert the batteries. Make sure the "+" and "-" battery contacts are correctly oriented (See Picture 2).
 (Note: Please use 2 pieces of AA alkaline batteries or AA type NI-MH batteries).
 Replace the battery cover and push back into the locked position.

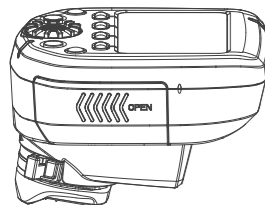

Picture 1

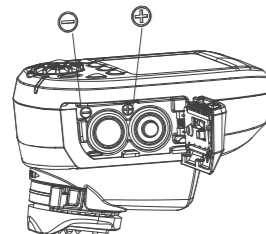

Picture 2

ATTACHING

1. Turn off the camera and the Elinchrom transmitter.
2. Align the Elinchrom transmitter's hotshoe with the camera's hotshoe mount.
3. Slide it all the way on the camera's hotshoe mount.
4. Lock the mounting foot from left to right until the locking lever clicks in place. (See picture 3)

DETACHING

1. Unlock: press the lock-release button while sliding from right to left. (see picture 4)
2. Slide the Elinchrom transmitter off the camera's hotshoe mount.

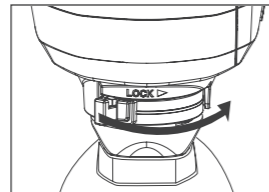

Picture 3

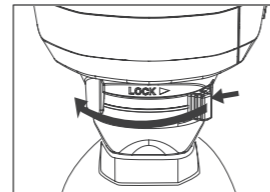

Picture 4

RESETTING THE TRANSMITTER

- Turn on the Elinchrom Transmitter
- Set to "Manual Mode"
- Press the "Manual/ TTL" button and the "Setup / Exit" button at the same time for two seconds.
- To refresh the EV values, please press the "Refresh" button for two seconds.

**The TTL values are saved while switching to the "Manual" mode

CONTROL PANEL

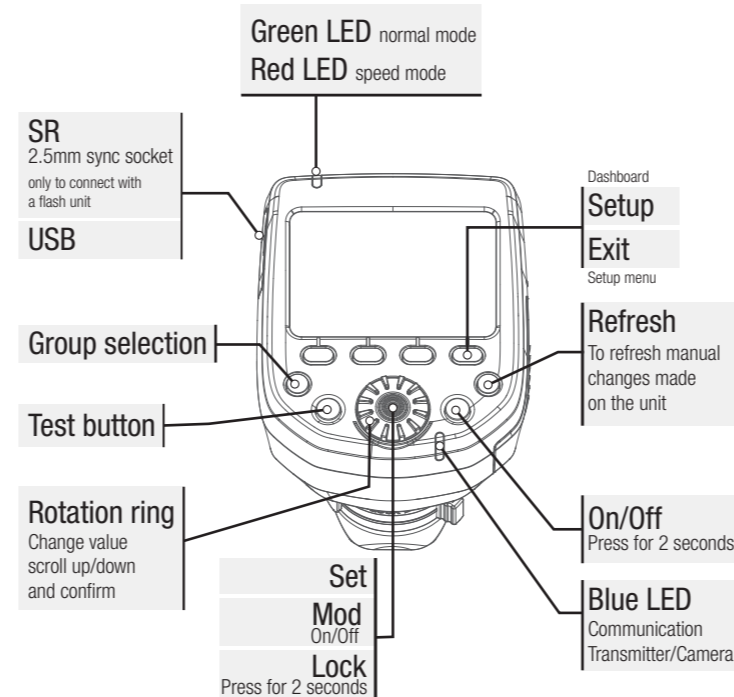

DISPLAY PANEL - DASHBOARD

Manual Mode

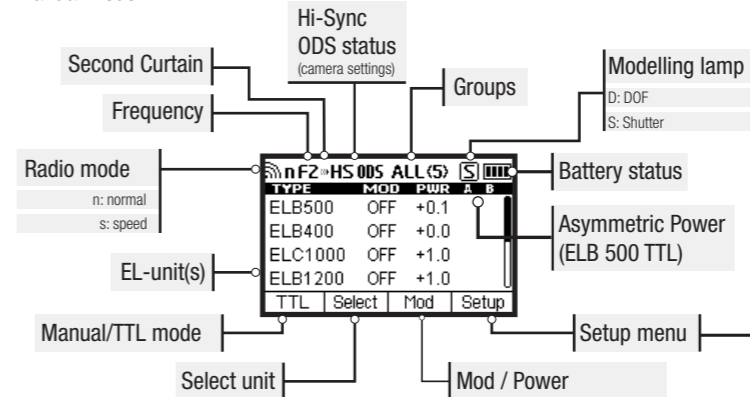

TTL Mode

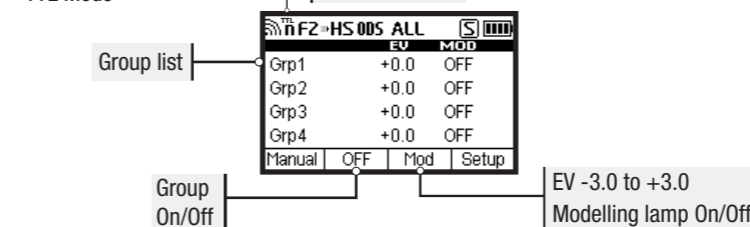

- Scan** search up to 10 EL-units
- Frequency** change frequency channel from 1 to 20
- ELSP mode** normal (green backlight)
speed (red backlight)
- SC Setup** second curtain on/off
- ODS setup** off from 0.1 to 5.0 ms
- Auto MOD** off shutter DOF
- AF Light** off on
- Key click** off on
- Sleep** off from 1 to 59 min
- Auto off** off from 1 to 60 min
- Contrast** from 80 to 120%
- Backlight** off on
- Pwr Display** F-Stop Ws
- Iden** Type Name ID